



UNITED NATIONS

ECONOMIC COMMISSION FOR WESTERN

ESCWA Documents converted to CDs

CD # 6

Directory Name

ECWA\INF2

Done by ProgressSoft Corp P O Box 802 Amman 11941 Jordan

ECONOMIC COMMISSION

FOR

WESTERN ASIA

(ECWA)

UN ECONOMIC COMMISSION
FOR WESTERN ASIA
24 JAN 1974
LIBRARY



UNITED NATIONS

BEIRUT, 1974

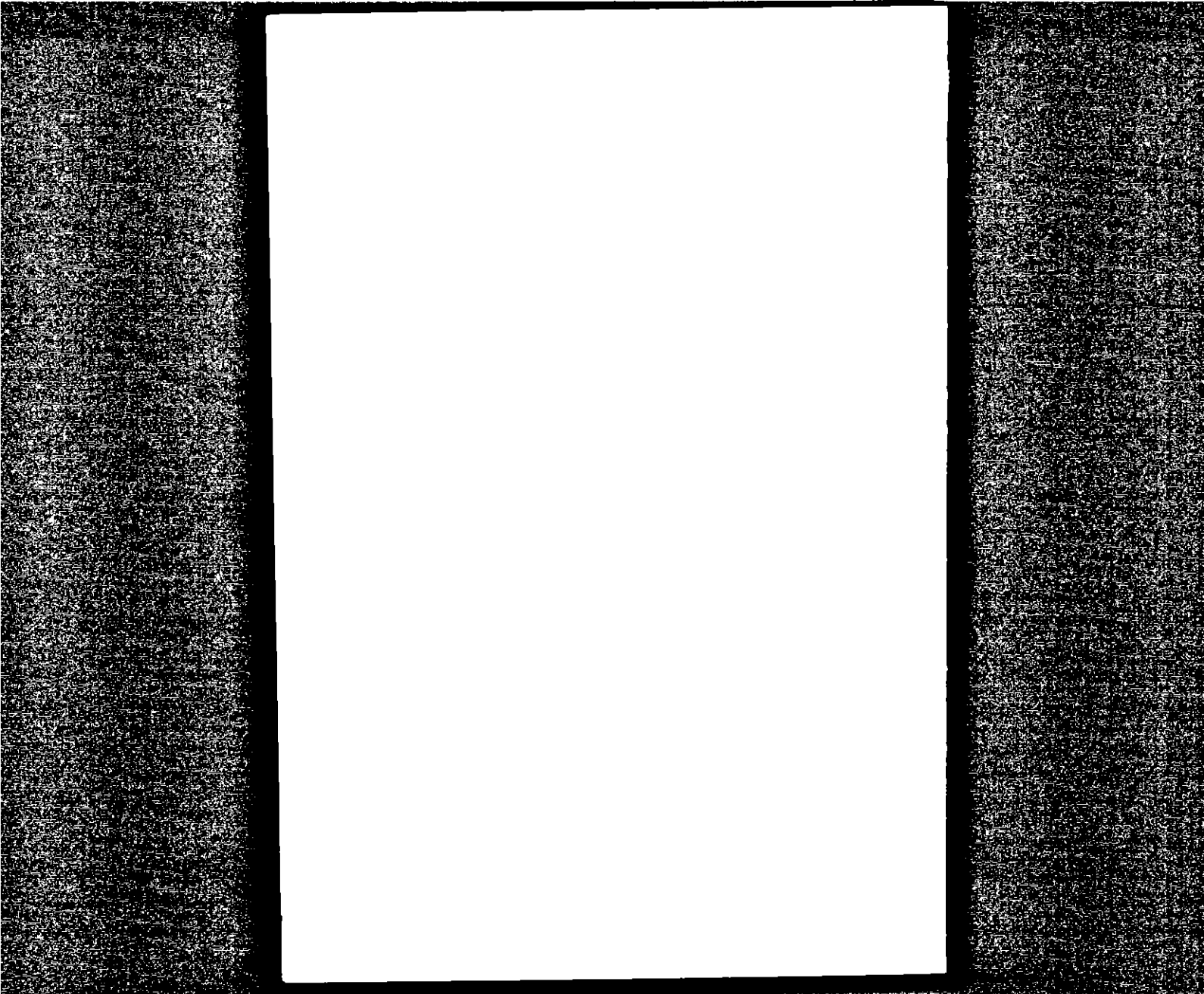

Establishment of the Commission

On 9 August 1973, at its 1878th plenary meeting, by its resolution 1818 (LV) entitled **Establishment of an economic commission for Western Asia,**

The Economic and Social Council,

Recognizing the special role of the regional economic commission in the implementation of the International Development Strategy for the Second United Nations Development Decade

Bearing in mind that the countries of Western Asia at present covered by the United Nations Economic and Social Office in Beirut do not enjoy membership in any regional economic commission

Believing that such membership would be an important factor in accelerating their economic and social development,

Establishes an Economic Commission for Western Asia, to start its operations on 1 January 1974 with terms of reference as follows

- 1 The Economic Commission for Western Asia, acting within the framework of the policies of the United Nations and subject to the general supervision of the Economic and Social Council shall, provided that the Commission takes no action in respect of any country without the agreement of the Government of that country
 - (a) Initiate and participate in measures for facilitating concerted action for the economic reconstruction and development of Western Asia, for raising the level of economic activity in Western Asia and for maintaining and strengthening the economic relations of the countries of that area both among themselves and with other countries of the world,

- (b) Make or sponsor such investigations and studies of economic and technological problems and developments within the territories of Western Asia as the Commission deems appropriate,
- (c) Undertake or sponsor the collection, evaluation and dissemination of such economic, technological and statistical information as the Commission deems appropriate,
- (d) Perform such advisory services within the available resources of its secretariat, as the countries of the region may desire, provided that such services do not overlap with those rendered by the specialized agencies or the United Nations Development Programme,
- (e) Assist the Council, at its request in discharging its functions within the region in connexion with any economic problems including problems in the field of technical assistance
- (f) In carrying out the above functions, deal, as appropriate, with the social aspects of economic development and the interrelationship of the economic and social factors

2 The members of the Commission shall consist of the States Members of the United Nations situated in Western Asia which at present call on the services of the United Nations Economic and Social Office in Beirut Future applications for membership by Member States shall be decided on by the Council upon the recommendation of the Commission

3 The Commission is empowered to make recommendations on any matters within its competence directly to the Governments of members concerned, Governments admitted in consultative capacity and the specialized agencies concerned The Commission shall

submit for the Council's prior consideration any of its proposals for activities that would have important effects on the economy of the world as a whole

- 4 The Commission may invite any State Member of the United Nations not a member of the Commission to participate in a consultative capacity in its consideration of any matter of particular concern to that non-member
- 5 The Commission may make arrangements for consultation with non-governmental organizations which have been granted consultative status by the Council in accordance with the principles approved by the Council for this purpose and contained in its resolution 1296 (XLIV) of 23 May 1968
- 6 The Commission may after discussion with any specialized agency functioning in the same general field, and with the approval of the Council establish such subsidiary bodies as it deems appropriate for facilitating the carrying out of its responsibilities
- 7 The Commission shall invite representatives of specialized agencies and may invite representatives of any intergovernmental organizations to participate in a consultative capacity in its consideration of any matter of particular concern to those agencies or organizations following the practice of the Council
- 8 The Commission shall take measures to ensure that the necessary liaison is maintained with other organs of the United Nations and with the specialized agencies The Commission shall establish appropriate liaison and co-operation with other regional economic commissions in accordance with the directives contained in the resolutions and decisions of the Economic and Social Council and the General Assembly

- 9 The Commission shall adopt its own rules of procedure, including the method of selecting its Chairman
- 10 The administrative budget of the Commission shall be financed from the funds of the United Nations
- 11 The Secretary General of the United Nations shall appoint the staff of the Commission, which shall form part of the Secretariat of the United Nations
- 12 The Commission shall submit to the Council a full report on its activities and plans including those of any subsidiary bodies, once a year

ECWA and the UN System

ECWA is the fifth Regional Economic Commission alongside the Economic Commission for Europe (ECE) the Economic Commission for Asia and the Far East (ECAFE), the Economic Commission for Latin America (ECLA) and the Economic Commission for Africa (ECA) It reports to the Economic and Social Council (ECOSOC)

The basic aim of the five regional economic commissions is to assist in raising the level of economic activity in their respective regions and to maintain and strengthen the economic relations of the countries in each region both among themselves and with other countries of the world

As subsidiary organs of the Economic and Social Council the Commissions report to it annually on their activities

The Economic and Social Council is one of the main organs of the United Nations

It is responsible, under the authority of the General Assembly, for the economic and social activities of the United Nations

The Council works through Commissions, Committees and various other subsidiary bodies

The following charts show respectively the place of ECWA in the economic and social area of activities of the United Nations and its place among the various Commissions, Committees and other subsidiary bodies of the Economic and Social Council

THE PLACE OF ECWA IN THE ECONOMY
UNITED NATIONS

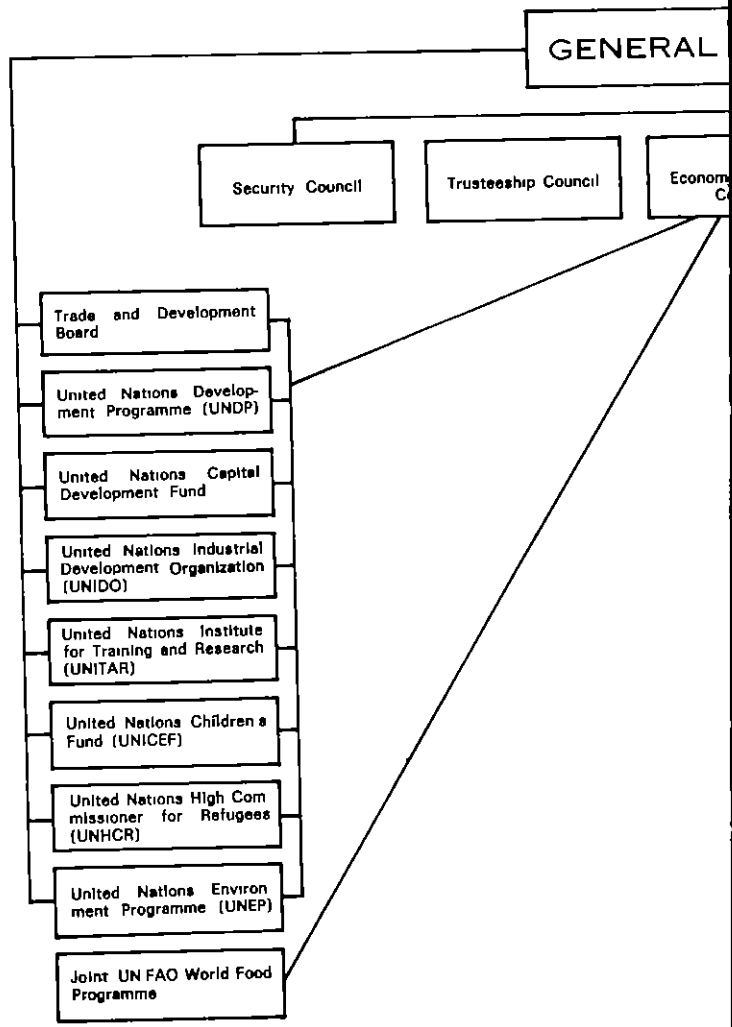

AND SOCIAL AREA OF ACTIVITIES OF THE
IONS SYSTEM

ASSEMBLY

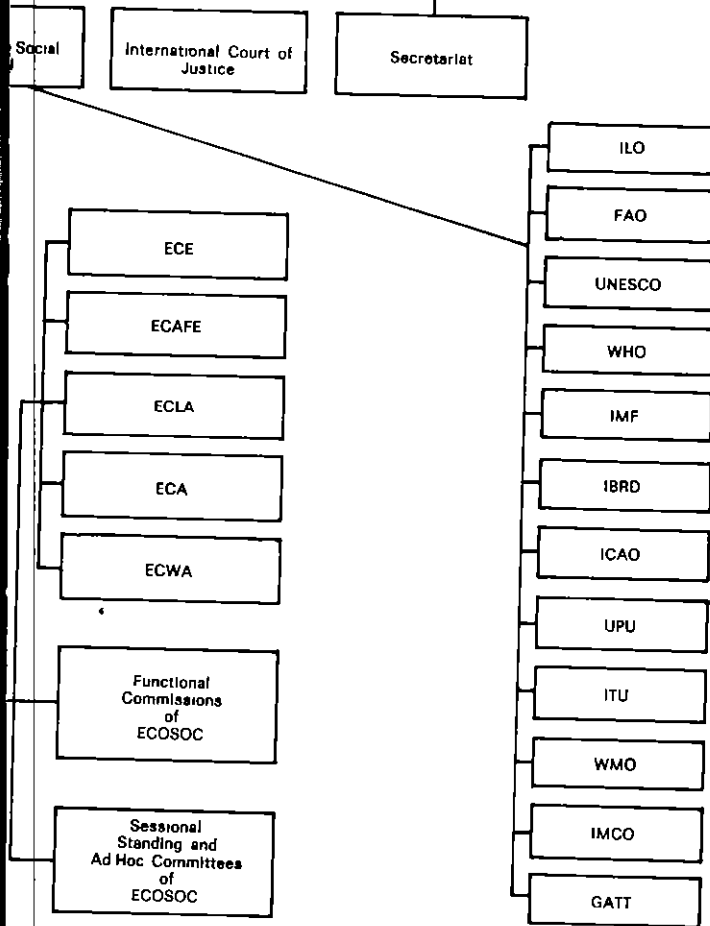

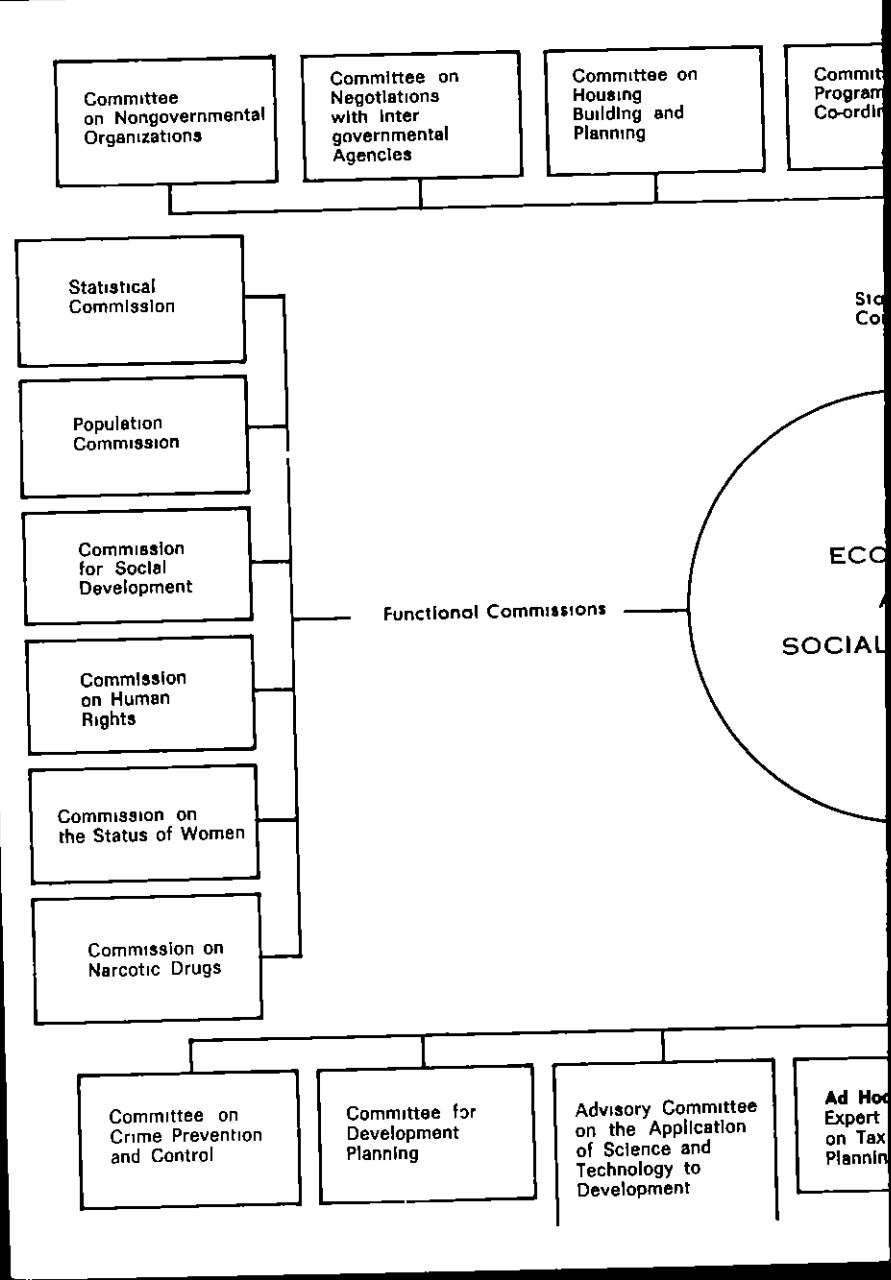

Committee on Nongovernmental Organizations

Committee on Negotiations with Inter governmental Agencies

Committee on Housing Building and Planning

Committee Program Co-ordin

Statistical Commission

Population Commission

Commission for Social Development

Commission on Human Rights

Commission on the Status of Women

Commission on Narcotic Drugs

Functional Commissions

Stat
Co

ECONOMY
SOCIAL

Committee on Crime Prevention and Control

Committee for Development Planning

Advisory Committee on the Application of Science and Technology to Development

Ad Hoc Expert on Tax Planning

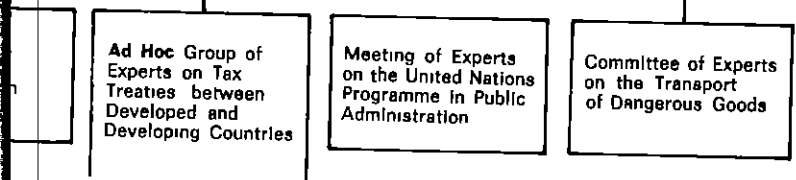
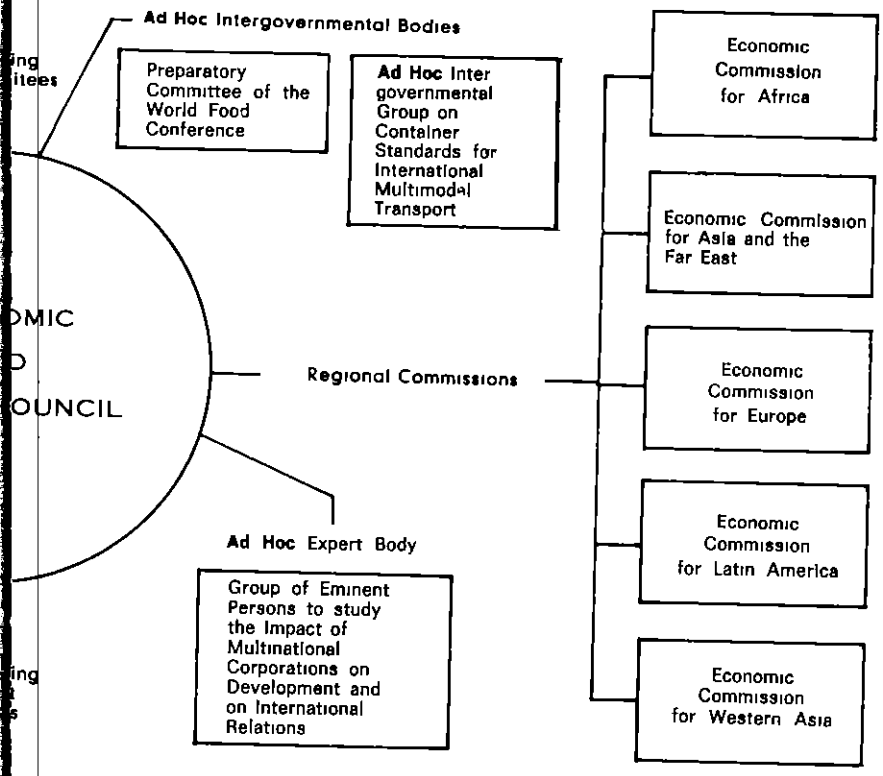
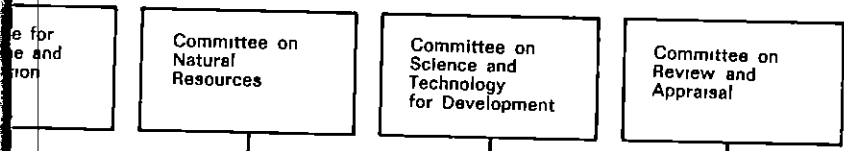

The Membership of ECWA

The ECOSOC resolution which established ECWA stated in paragraph 2 of the terms of reference

The members of the Commission shall consist of the States Members of the United Nations situated in Western Asia which at present call on the services of the United Nations Economic and Social Office in Beirut. Future applications for membership by Member States shall be decided on by the Council upon the recommendation of the Commission.

These members are

Bahrain
Democratic Republic of Yemen
Iraq
Jordan
Kuwait
Lebanon
Oman
Qatar
Saudi Arabia
Syria
United Arab Emirates
Yemen Arab Republic

The Secretariat of ECWA

The Secretariat of ECWA which is an integral part of the Secretariat of the United Nations, is headed by the Executive Secretary.

The first incumbent of this post has been appointed by the Secretary General of the United Nations. He is Dr. Mohamed Said Al Attar.

Born on 26 November 1927 Dr Al-Attar obtained a degree from the University of Paris and a doctorate in economics and social science from the Faculté des Lettres at the Sorbonne. In 1962 Dr Al-Attar became General Director of the Yemen Bank for Reconstruction and Development and later served from 1968 to 1971 as the Bank's President. From 1965 to 1968 he served twice as Yemen's Minister of the Economy and was a member of the High Committee for Planning. In 1965 he was also Minister of State. Dr Al-Attar was Yemen's Permanent Representative to the United Nations from September 1968 to April 1971, and was again appointed to the post in March 1973. In the interim he held the rank of Ambassador in the Ministry of Foreign Affairs at Sana'a representing his country at the 1971 Conference of the World Bank and the International Monetary Fund, and at the 1972 General Conference of the United Nations Educational, Scientific and Cultural Organization.

ECWA, which has absorbed the staff of the former United Nations Economic and Social Office in Beirut (UNESOB), is in the process of organizing its Secretariat.

The Activities of ECWA

The activities which ECWA will undertake are derived from its terms of reference which are contained in the resolution of its establishment.

The work programme will be developed on the basis of the priorities decided upon by the Member States of the Commission at its first session, scheduled to be held in Beirut in June 1974.

In order to provide the necessary technical basis for implementing its work programme the Commission is authorized by ECOSOC to initiate or participate in measures investigations and studies of economic, social and technological problems, and to collect, evaluate, and disseminate the relevant information as well as assist in the formulation and development of coordinated policies among member countries of ECWA with a view to promoting their economic development

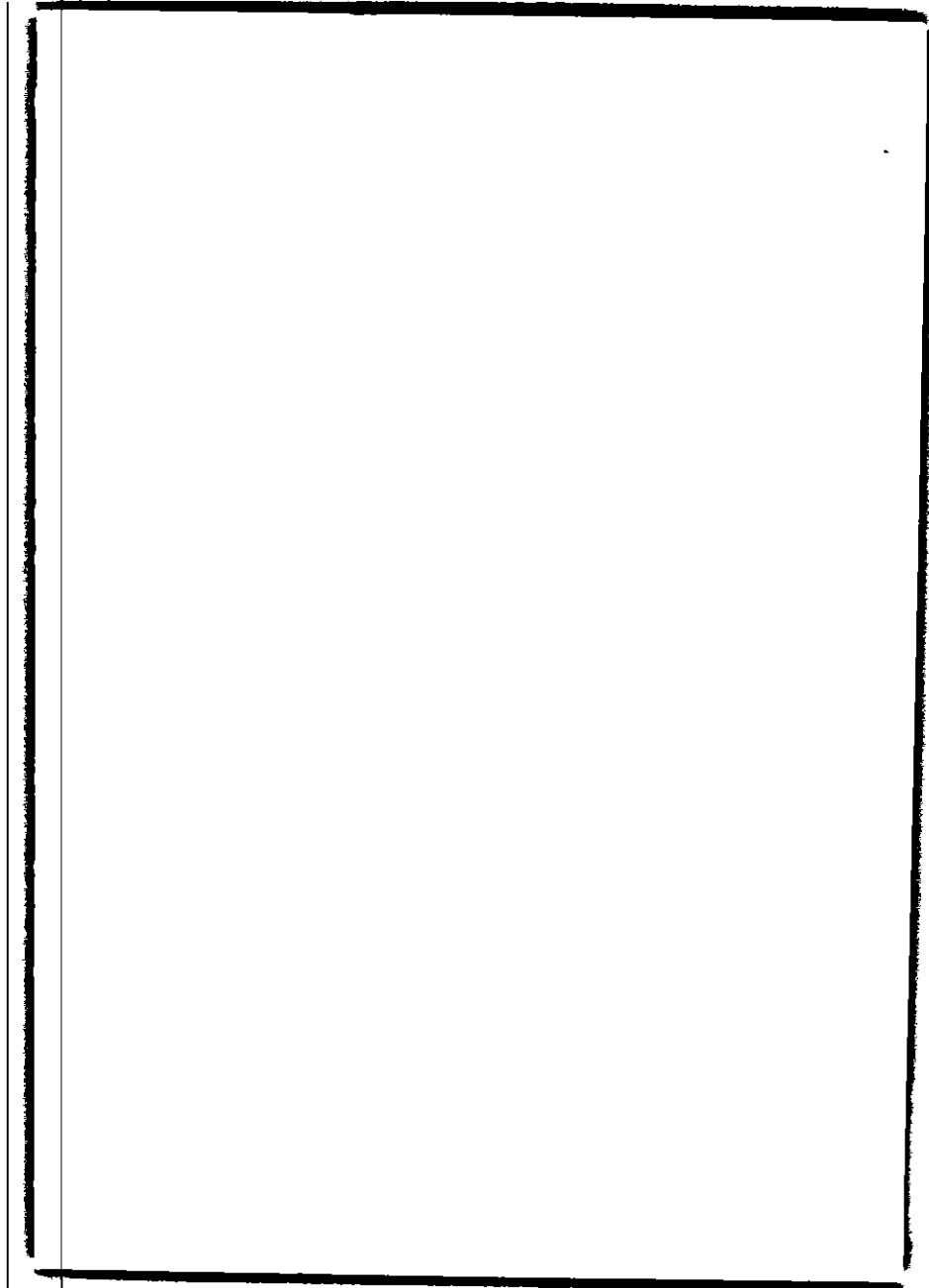

E / ECWA / INF 1

PRINTED IN LEBANON
74 0001 MARCH 1974 2500
E / ECWA / INF 1

UNITED NATIONS BLDG BIR HASSAN
P O BOX 4656 BEIRUT LEBANON
TEL 272925 / 6 / 7 / 8
CABLE ADDRESS UNATIONS BEIRUT

UNESCWA LIBRARY



20047233